

Fishfinder 400C

owner's manual



GARMINTM

© 2006, 2007 Garmin Ltd. or its subsidiaries

Garmin International, Inc.
1200 East 151st Street,
Olathe, Kansas 66062, USA
Tel. (913) 397.8200 or (800) 800.1020
Fax (913) 397.8282

Garmin (Europe) Ltd.
Liberty House
Hounslow Business Park,
Southampton, Hampshire, SO40 9RB UK
Tel. +44 (0) 870.8501241 (outside the UK)
0808 2380000 (within the UK)
Fax +44 (0) 870.8501251

Garmin Corporation
No. 68, Jangshu 2nd Road,
Shijr, Taipei County, Taiwan
Tel. 886/2.2642.9199
Fax 886/2.2642.9099

All rights reserved. Except as expressly provided herein, no part of this manual may be reproduced, copied, transmitted, disseminated, downloaded or stored in any storage medium, for any purpose without the express prior written consent of Garmin. Garmin hereby grants permission to download a single copy of this manual onto a hard drive or other electronic storage medium to be viewed and to print one copy of this manual or of any revision hereto, provided that such electronic or printed copy of this manual must contain the complete text of this copyright notice and provided further that any unauthorized commercial distribution of this manual or any revision hereto is strictly prohibited.



Information in this document is subject to change without notice. Garmin reserves the right to change or improve its products and to make changes in the content without obligation to notify any person or organization of such changes or improvements. Visit the Garmin Web site (www.garmin.com) for current updates and supplemental information concerning the use and operation of this and other Garmin products.

Garmin[®], CANet[™], See-Thru[®], and Ultrascroll[™] are registered trademarks or trademarks of Garmin Ltd. or its subsidiaries and may not be used without the express permission of Garmin.

INTRODUCTION

The Fishfinder 400C is a full-featured, color sonar that offers a choice of display styles, a dual beam or dual frequency option, and more.

Fishfinder 400C Tips and Shortcuts

- Press **HOME** from any screen to return to the Home screen.
- Press **MENU** from any of the main screens to access advanced settings.
- Press and release the  **POWER** key to adjust the display settings.

Quick Links

- Installing the Fishfinder 400C: [page 1](#)
- Mounting the Fishfinder 400C: [page 2](#)
- Installing the Transducer: [page 4](#)
- Basic Operation: [page 15](#)
- Customizing the Fishfinder 400C: [page 21](#)
- Changing the System Settings: [page 23](#)
- Customizing the Transducer Settings: [page 23](#)
- Advanced Settings: [page 25](#)
- Alarms and Messages: [page 28](#)

Table of Contents

Introduction	i	Understanding the Numbers Screen	19
Fishfinder 400C Tips and Shortcuts	i	Understanding the Temp Log Screen	19
Quick Links	i	Understanding the Configure Screen	20
Product Registration	iii	Customizing the Fishfinder 400C	21
Caring for the Fishfinder 400C	iii	Setting Alarms	21
Warnings	iv	Changing the Display Settings	21
Important Information	iv	Changing the Sonar Settings	22
Installing the Fishfinder 400C	1	Changing the System Settings	23
Step 1: Select a Location for the Fishfinder	1	Configuring Transducer Settings	23
Step 2: Mount the Fishfinder	2	Customizing Units of Measure	24
Step 3: Install the Transducer	4	Advanced Settings	25
Step 4: Install the Wiring Harness	10	Resetting the Odometer.....	26
Step 5: Test the Installation	13	Setting the Temp Log Duration and Scale	26
Basic Operation	15	Appendix	27
Turning the Fishfinder 400C On or Off	15	Specifications	27
Adjusting the Backlight Setting	15	Optional Accessories	27
Using Simulator Mode	15	Alarms and Messages.....	28
Using the Fishfinder 400C Keypad	15	Limited Warranty	29
Understanding the Home Screen.....	16	Declaration of Conformity (DoC)	30
Understanding the Full Screen	17	Software License Agreement	30
Understanding the Split Zoom Screen	17	Index	31
Understanding the Flasher Screen	18		
Understanding the Split Freq Screen	18		

Product Registration

Help us better support you by completing our online registration today! Connect to our Web site at www.garmin.com/registration/.

Use this area to record the serial number (8-digit number located on the back of the Fishfinder 400C) in case your Fishfinder 400C needs service. Keep the original sales receipt, or a photocopy, in a safe place.

Serial Number: ___ ___ ___ ___ ___ ___ ___ ___

Contact Garmin

Contact Garmin if you have any questions while using your Fishfinder 400C. In the USA contact Garmin Product Support by phone: (913) 397-8200 or (800) 800-1020, Monday–Friday, 8 AM–5 PM Central Time; or go to www.garmin.com/support/, and click **Product Support**.

In Europe, contact Garmin (Europe) Ltd. at +44 (0) 870.8501241 (outside the UK) or 0808 2380000 (within the UK).

Tell Us What You Think

Tell us how you like this manual! Fill out the Product Documentation Survey. Go to www.garmin.com/contactUs/, and click **Product Documentation Survey**.

Caring for the Fishfinder 400C

The case is constructed of high-quality materials and does not require user maintenance, except cleaning.

Cleaning the Case

Clean the unit's outer casing (except for the screen) using a cloth dampened with a mild detergent solution and then wipe dry. Avoid chemical cleaners and solvents that may damage plastic components.

Cleaning the Screen

The unit's lens is coated with a special anti-reflective coating that is sensitive to skin oils, waxes and abrasive cleaners. Cleaners containing ammonia, alcohol, abrasives, or anti-grease detergents will harm the anti-reflective coating. It is important to clean the lens using an eyeglass lens cleaner (that is specified as safe for anti-reflective coatings) and a clean, lint-free cloth.

Water Immersion

The unit is waterproof to IEC Standard 60529 IPX7. It can withstand immersion in 1 meter of water for 30 minutes. Prolonged submersion can cause damage to the unit. After submersion, be certain to wipe and air dry the unit before reuse.

Warnings

Failure to avoid the following potentially hazardous situations could result in an accident or collision resulting in death or serious injury.

- When navigating, carefully compare information displayed on the unit to all available navigation sources, including information from visual sightings, and maps. For safety, always resolve any discrepancies or questions before continuing navigation.

WARNING: This product, its packaging, and its components contain chemicals known to the State of California to cause cancer, birth defects, or reproductive harm. This Notice is provided in accordance with California's Proposition 65. See www.garmin.com/prop65 for more information.

 - LAMPS INSIDE THIS PRODUCT CONTAIN MERCURY AND MUST BE RECYCLED OR DISPOSED OF ACCORDING TO LOCAL, STATE, OR FEDERAL LAWS.

For more information go to:

www.garmin.com/aboutGarmin/environment/disposal.jsp.

Important Information

The **California Waste Recycling Act of 2003** requires the recycling of certain electronics. For more information on the applicability to this product, see www.ecycle.org.

INSTALLING THE FISHFINDER 400C

To successfully operate your Fishfinder 400C, you must properly install the fishfinder and all of its related parts. Compare the contents of this package with the packing list on the box. If any pieces are missing, contact your Garmin dealer immediately. Before you begin the installation:

- Read and follow the instructions to install the unit.
- Gather the appropriate fasteners and tools.
- Verify that all cables can reach the unit mounting location and the transducer.
- Wear safety goggles and a dust mask when drilling, cutting, or sanding.

If you experience difficulty installing the unit, contact Garmin Product Support or contact a professional installer.

To install and use your fishfinder:

1. Select a location for the fishfinder.
2. Mount the fishfinder.
3. Install the transducer.
4. Install the wiring harness.
5. Test the installation.

Step 1: Select a Location for the Fishfinder

Consider the following when you select an installation location:

- Provides optimal viewing as you operate your vessel.
- Allows easy access to the unit's keypad.
- Is strong enough to support the weight of the fishfinder and protect it from excessive vibration or shock.
- Allows room for the routing and connection of the power/data and transducer cables. There should be at least a 3-inch (8 cm) clearance behind the case.

DO NOT mount the unit in an area that is exposed to extreme temperature conditions.



NOTE: The temperature range for the Fishfinder 400C is 5°F to 131°F (-15°C to 55°C). Extended exposure to temperatures exceeding this range (in storage or operating conditions) may cause failure of the LCD screen. This type of failure and related consequences are NOT covered by the manufacturer's limited warranty.

Step 2: Mount the Fishfinder

You can mount your fishfinder in one of two ways:

- **Surface Mount**—mount the fishfinder onto a bracket (included) that attaches to the console or overhead.
- **Flush Mount**—use the optional flush mount kit to mount the fishfinder into a flat panel. See the “Appendix” for more information.

Surface Mounting the Fishfinder

The Fishfinder 400C’s compact, waterproof case is suitable for mounting in exposed locations or at the nav station. The Fishfinder 400C comes with a tilt/swivel mounting bracket that can be used for console or overhead mounting.

Mounting the Bracket Assembly

Tools (not included)—drill, screwdriver (Phillips or standard), and one of the following:

- Three #8 (4 mm) pan-head machine bolts with matching nuts and washers and a 5/32" (5 mm) drill bit.
- Three #8 pan-head self-tapping screws and a 1/16" drill bit for drilling starter holes.

Use a pan-head machine bolt or self-tapping screw to secure the swivel base. If you use a screw with a countersunk head, you risk damaging the mounting bracket.

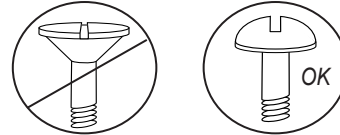

To mount the bracket assembly:

- Using the swivel base as a template, mark the location of the three holes that secure the bracket to the mounting surface.
 - Drill the mounting holes.
 - If you secure the base with machine bolts, drill three 5/32" (5 mm) holes at the locations you marked.
- OR
- If you secure the base with self-tapping screws, drill starter holes at the locations you marked. Do not make the starter holes deeper than half the screw length.



- Secure the swivel base with three bolts or screws. **DO NOT OVERTIGHTEN.**
- Place the swivel mount bracket over the swivel base and secure it with the short knob.

Installing the Fishfinder 400C on the Mounting Bracket**To install the unit on the mounting bracket:**

- Align the slot on the back of the fishfinder with the long mounting knob, and slide the fishfinder into place. If necessary, adjust the long knob to spread the bracket arms apart. (Turn counter-clockwise to widen the bracket arms and clockwise to tighten.)
- Adjust the fishfinder angle, and tighten the long mounting knob until snug.



- Rotate the swivel mount bracket by twisting it left or right. The bracket clicks as you turn it. Select a good viewing angle, and then tighten all knobs.
- Connect the power/data and transducer cables to the back of the fishfinder, making sure the locking rings are fully tightened on both connectors.

Step 3: Install the Transducer

Proper transducer installation is key to getting the best performance from your fishfinder. If the transducer lead is too short, extension cables are available from your Garmin dealer. Coil and secure any excess cable.



CAUTION: DO NOT cut the transducer lead or any part of the transducer cable, because cutting the transducer cable voids your warranty. The cable cannot be spliced and connected to any existing (Garmin or non-Garmin) transducer cables.

The following pages contain tips and basic installation instructions for some popular transducers. Detailed installation instructions are provided in the transducer kits. Some transducers might have to be installed by a professional marine installer.

Assembling the Transducer

To assemble the transducer:

1. Insert the rubber washer and plastic spacer into the transducer at the same time. DO NOT lubricate the rubber washer.
2. Route the cable toward the back of the transducer. Slide the transducer into the transducer mount.
3. Place a 5 mm flat washer on the 10-32 x 1.75" screw, and insert the screw through the transducer mount, spacer, and rubber washer.
4. Place the remaining 5 mm flat washer on the exposed end. Install the 10-32 lock nut finger tight. You can tighten the transducer further after installation on the boat.

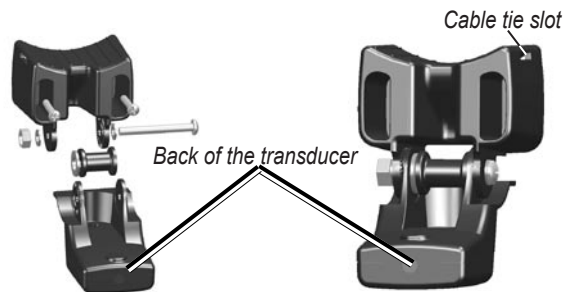

Mounting the Transducer on a Trolling Motor (Dual Beam Transducers Only)

To mount the transducer on a trolling motor:

1. Slide the large cable tie through the slot on the transducer mount with the ridges of the band facing up until equal lengths extend on both sides of the mount.



NOTE: For cold water, or heavy timber or debris areas, a metal 4-5" worm gear clamp is recommended.

2. Position the mount gasket on the curved top of the transducer mount.
3. Place the transducer assembly against the motor body of the trolling motor, with the front of the transducer pointed away from the trolling motor propeller.
4. Wrap the two ends of the cable tie around the motor body. Place the pointed end of the cable tie through the fastener hole on the opposite end and pull it through until it is snug but not tight. (The cable tie clicks when you pull it.)
5. Position the transducer so that it is parallel with the bottom when in use, and make sure the gasket is aligned properly. Pull the cable tie end until tight. Trim off the excess if necessary. Tighten the 10-32 locking nut until it touches the mounting bracket, and then tighten 1/4 turn more. (Do not overtighten.)

6. Route the 30-foot (9 m) transducer cable using the supplied cable ties to secure the cable to the motor shaft. You can fill the forward-facing portion (except the cable tie pocket) of the transducer mount with sealant to avoid accumulating debris.

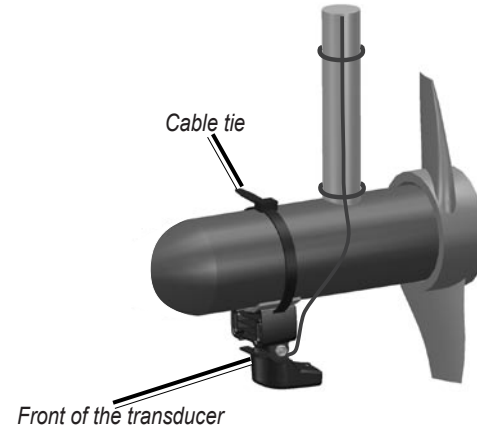

Mounting the Transducer on a Transom

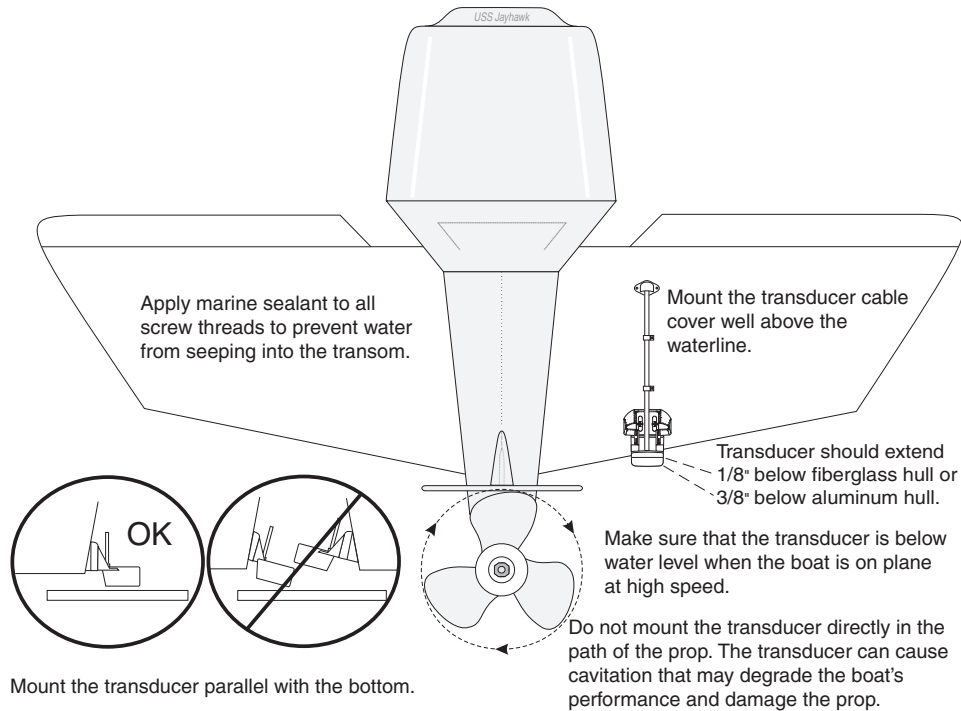

When selecting a transom mount location, consider the following for optimal performance:

- For your sonar to operate properly, the transducer must be located in calm water. DO NOT mount the transducer behind strakes, rivet lines, struts, fittings, water intake, discharge ports, eroding paint, or anything that creates turbulence.
- Mount the transducer as close to the center of the boat as possible.
- DO NOT cut the transducer lead. (This voids your warranty.)
- DO NOT mount the transducer in locations where it might be jarred when launching, hauling, trailering, or storing.
- DO NOT mount the transducer in the path of the prop on single-drive boats. The transducer can cause cavitation that can degrade the boat's performance and damage the prop. On twin-drive boats, mount the transducer between the drives, if possible.



NOTE: DO NOT mount the transducer behind strakes, struts, fittings, water intake or discharge ports, or anything that creates air bubbles or causes the water to become turbulent. The transducer must be in clean (non-turbulent) water for optimal performance.

Tool List (not included)—drill, 3/8" wrench or socket, 5/32" and 1/8" drill bits, masking tape, #2 Phillips screwdriver, and marine sealant.

To mount the transducer on a transom:

1. Position the transducer mount at the selected transom location. Make sure the transducer is parallel with the water line. Mark the center locations of each hole on the transducer mount.
2. Using a 5/32" bit, drill the pilot holes approximately 1" (25 mm) deep at the marked locations. To avoid drilling the holes too deep, wrap a piece of tape around the bit at 1" from the point of the bit.
3. Apply marine sealant to the 5 x 30 mm screws. Attach the transducer assembly to the transom using the 5 x 30 mm screws. Adjust the transducer assembly to extend beyond the bottom of the transom approximately 1/8" (3 mm) on fiberglass hulls or 3/8" (10 mm) on aluminum hulls. Adjust the transducer assembly to be aligned parallel with the water.
4. Tighten the 10-32 locking nut until it touches the mounting bracket, and then tighten 1/4 turn more. (Do not overtighten.)
5. Place the first cable clamp on the transducer cable approximately one third of the distance between the transducer and the top of the transom.

6. Mark the location. Using a 1/8" bit, drill a pilot hole approximately 3/8" (10 mm) deep.
7. Attach the cable clamp using a 4 x 12 mm screw. Coat the screw with marine sealant before installation. Repeat steps 5 and 6 using the other cable clamp.
8. Route the transducer cable, as needed, to the fishfinder. DO NOT CUT THE CABLE. Avoid routing the cable with electrical wires or other sources of electrical interference.

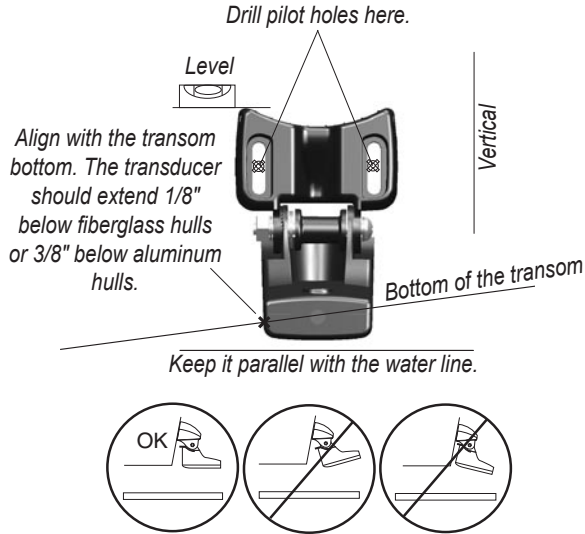

Shoot-Thru-Hull Installation

To avoid drilling a hole to mount a thru-hull transducer, a transducer can be secured with epoxy inside a boat (shoot-thru-hull installation). This type of installation can provide better noise reduction and allow you to use a higher Gain setting. For a transducer to be mounted inside the hull (shoot-thru, not thru-hull), the boat must be fiberglass, with no core. Contact your boat manufacturer if you are unsure. Professional installation might be necessary.

Some transducers are specifically designed to be mounted inside a fiberglass hull. The standard plastic transom mount transducer can also be mounted using this method. If using a temperature sensing transducer, the temperature shown reflects the hull temperature.

Selecting a Location for a Shoot-Thru-Hull Installation

When installing a transducer, the installation location must be the following:

- Solid fiberglass, without any air bubbles, laminates, fillers, or dead air space.
- In an area of clean (non-turbulent) water at all speeds.
- The location must not be over any strakes or behind any obstruction on the hull that would create turbulence.



NOTE: Many modern hulls have a dedicated pocket for shoot-thru-hull transducer installation. If you are unsure if your hull is equipped with a pre-located pocket, contact your hull manufacturer.

To test the location:

1. Fabricate a test device from a section of PVC pipe or a can, as shown in the following illustration.
2. Temporarily seal the test device to the hull with caulking or RTV sealer, and fill with water or light mineral oil.
3. Place the transducer in the water, pointed directly at the bottom and weight it down. Set the unit for optimum performance. If the sonar performance is significantly degraded, another location must be tested.

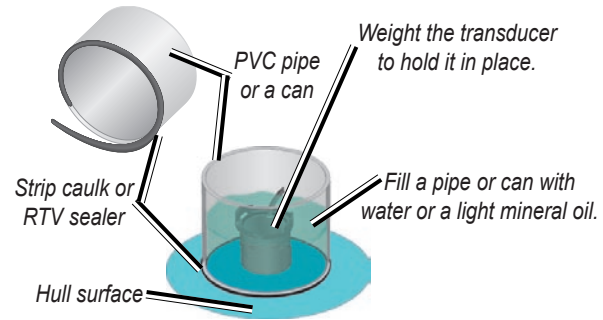

Testing the Location

To permanently install the transducer:

1. Lightly sand the surface of the hull and face of the transducer with 400 grit wet or dry sandpaper.
2. Build a dam using strip caulk about 1/4" (6 mm) tall. Pour about 1/8" (3 mm) of two-part, slow-cure epoxy into the dam.
3. Place the transducer in the epoxy, turning the transducer to work out any air bubbles.
4. Weight the transducer in place, and allow it to cure for 24 hours.

Step 4: Install the Wiring Harness

The Fishfinder 400C comes with a wiring harness that connects the fishfinder to power and the transducer with one easy-to-remove connection and provides interface capabilities for connecting external devices.

The color code in the diagram (see [page 11](#)) indicates the appropriate harness connections. The replacement fuse is a AGC/ 3AG - 3 Amp fuse. If it is necessary to extend the power wires, use 22 AWG wire. DO NOT cut the transducer cable, because this voids your warranty. If your boat has an electrical system, you might be able to wire the fishfinder directly to an unused holder on your current fuse block. If you are using the boat's fuse block, remove the in-line fuse holder supplied with the fishfinder. You can also wire the fishfinder directly to the battery.



CAUTION: The Fishfinder 400C maximum input voltage is 35 Volts DC. Do not exceed this voltage, because this can damage the Fishfinder 400C and void the warranty.



NOTE: During a typical installation, use only the Red and Black wires. The other wires do not have to be connected for normal operation of the Fishfinder 400C unit. For information on connecting to a NMEA or CANet compatible device, see [page 12](#).

To install the wiring harness:

1. Use a test light or voltmeter to determine the polarity of the voltage source.
2. Connect the Red (+ or positive) wire to the positive voltage terminal. (If you use the boat's fuse block, route the positive connection through the fuse, as shown on the diagram.)
3. Connect the Black (- or ground) wire to the negative voltage terminal.
4. Install or check the 3-Amp fuse (on the boat's fuse block or in the in-line holder).
5. Align the notches on the cable plug and on the back of the fishfinder. Insert the cable into the connector, and turn the lock ring counter-clockwise until it stops.

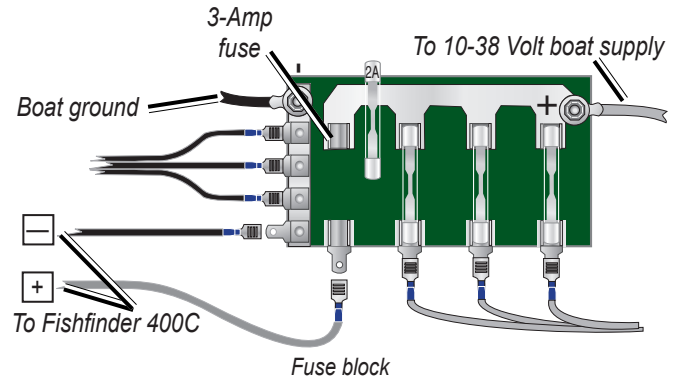

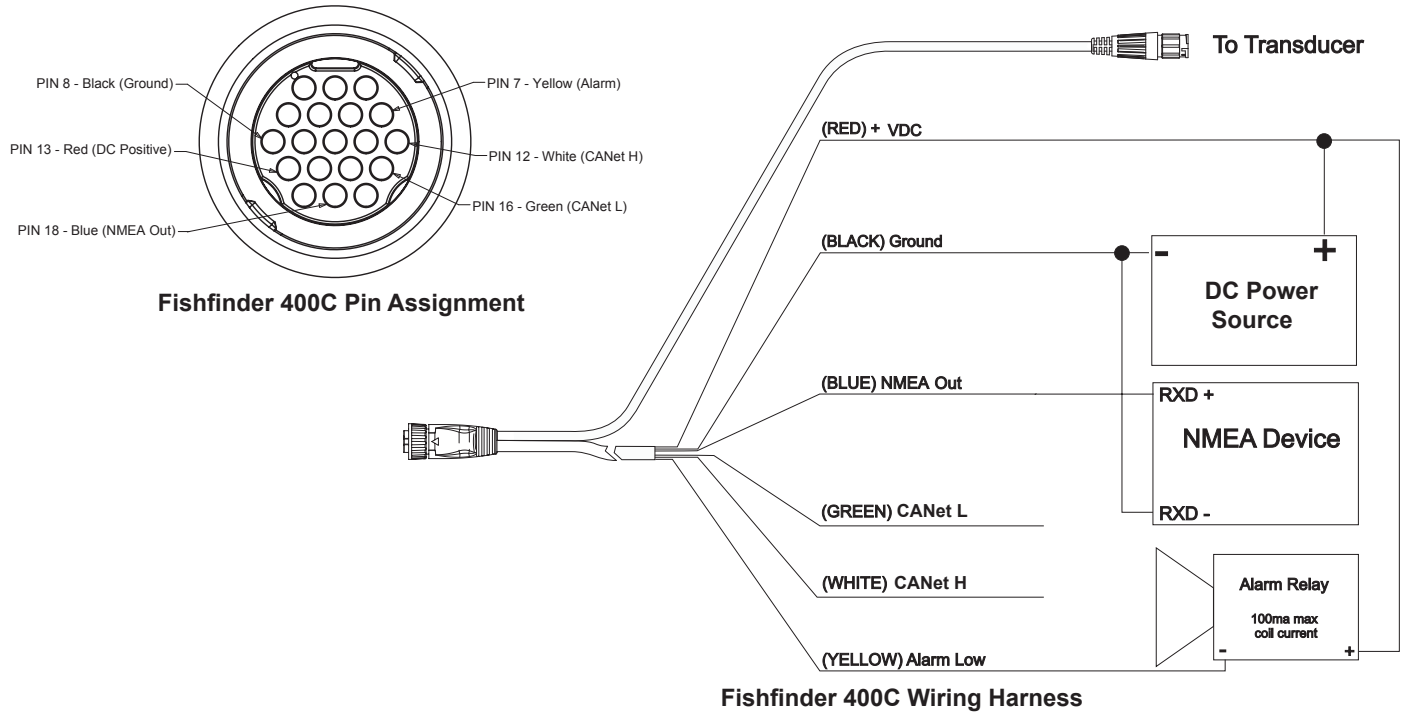

Connecting to a NMEA device

You can connect the Fishfinder 400C to another piece of NMEA compatible electronic equipment, such as a Garmin GPS (Global Positioning System) device. If equipped with a capable transducer, the Fishfinder 400C can send depth, temperature, and speed information. Refer to the wiring diagrams on [page 11](#) for connecting the Fishfinder 400C to NMEA compatible devices.

To install the wiring harness to a GPS or other NMEA device:

1. Follow the voltage source installation steps (see [page 10](#)). For Garmin units, the ground (Black) wires serve as NMEA ground and must be attached together or on the same terminal. Refer to the wiring diagram of your GPS unit for wire identification.
2. Connect the Blue (NMEA Out) wire from the Fishfinder 400C to the NMEA In wire on the GPS/NMEA unit's wiring harness.
3. Turn on the Fishfinder 400C **NMEA Output** setting ([page 23](#)). For Garmin GPS units, set the communications interface to **NMEA/NMEA, NMEA In/NMEA Out, or NMEA.**

Interfacing with NMEA

The Fishfinder 400C allows for NMEA 0183, Version 3.01 output with a compatible GPS or navigation device. You must set **NMEA Output On** to send data ([page 23](#)).

The SDDBT, SDDPT, SDMTW, SDVHW, SDWPL sentences are sent in NMEA 0183, Version 3.01 output from the Fishfinder 400C.

You can purchase complete information about National Marine Electronics Association (NMEA) format and sentences from:

NMEA

Seven Riggs Avenue

Severna Park, MD 21146 USA

www.nmea.org

Installing the Fishfinder 400C to a Garmin CANet

The Fishfinder 400C is a CANet-compatible sonar device.

Using the CANet (if applicable) optimizes the performance of CANet-compatible units, allowing sonar information from the Fishfinder 400C to be shared with up to two CANet compatible Garmin GPS units. A standard NMEA connection only allows depth, temperature, and speed information to be sent to a single GPS device, whereas a CANet connection provides full sonar readings, including Ultrascroll™, so you can view and control the same information on your compatible GPS unit(s) as you can on your Fishfinder 400C.



NOTE: To use the Garmin CANet with your Fishfinder 400C, you must obtain a CANet Kit. Contact your Garmin dealer, or visit www.garmin.com.

Step 5: Test the Installation

To turn on your Fishfinder 400C for the first time, press and hold the **POWER** key until the unit beeps and turns on. Use the **ROCKER** and the **SELECT** key and follow the screens to configure your Fishfinder 400C.



NOTE: Although it is possible to perform some checks with the boat trailered, the boat should be in the water to properly test the installation.

To configure your Fishfinder 400C for the first time:

1 Select a language.



2 Select a transducer type.



3 Select units of measure.



4 Select a color scheme.

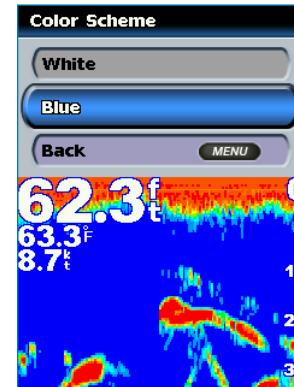

The Home screen appears after you select your configuration options. After 15 seconds of inactivity, the fishfinder automatically switches to Full Screen.



NOTE: If the transducer is not detected, a “Transducer Disconnected, Sonar Turned Off” message appears.

Because water is necessary to carry the sounder's sonar signal, the transducer must be in the water to work properly. You cannot get a depth or distance reading when out of the water.

When you place your boat in the water check for leaks around any screw holes that were added below the water line. **DO NOT** leave your boat in the water for an extended period of time without checking for leaks.

To test the transom mount transducer installation:

1. Begin testing the installation at a slow speed. If the sonar appears to be working properly, gradually increase the boat's speed while observing the sonar's operation. If the sonar signal is suddenly lost or the bottom return is severely degraded, note the speed at which this occurs.
2. Return the boat to the speed at which the signal was lost. Make moderate turns in both directions, and see if the signal improves.

3. If the signal strength improves while turning, adjust the transducer so that it extends another 1/8" below the transom of the boat. It might take several adjustments to eliminate the degradation.
4. If the signal does not improve, you might have to move the transducer to a different location.



NOTE: When adjusting the depth of the transducer, make the adjustments in small increments. Placing the transducer too deep can adversely affect the boat's performance and put the transducer at greater risk of striking underwater objects.

BASIC OPERATION

Turning the Fishfinder 400C On or Off

Press and hold the  **POWER** key until the unit beeps and the Home screen appears.



NOTE: When you turn on the Fishfinder 400C for the first time, you have to select a language, transducer type, units of measure, and color scheme.

Adjusting the Backlight Setting

1. Press and release the  **POWER** key.
2. Press left on the **ROCKER** to decrease the brightness; press right to increase.

Using Simulator Mode

If a transducer is not connected, no data is shown on the screens. By turning on Simulator Mode, the Fishfinder 400C acts as though a transducer is connected. Use Simulator Mode to practice and learn how to use your Fishfinder 400C.



CAUTION: When in Simulator Mode, the depth, temperature, and speed information are simulated. They do not represent the actual depth, water temperature, or vessel speed.

Using the Fishfinder 400C Keypad

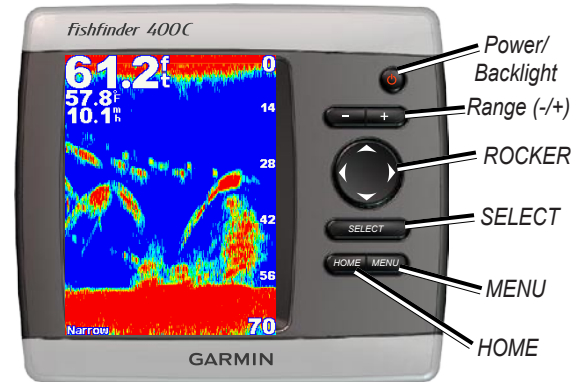

POWER/BACKLIGHT—Press and hold to turn the unit on or off; press and release to adjust the backlight and day/night modes.

RANGE (-/+)—Press to adjust the range of the sonar.

ROCKER—Press up, down, left, or right to move through menus, highlight fields, and enter data.

SELECT—Press to select highlighted items and confirm on-screen messages.

HOME—Press to return to the Home screen.

MENU—Press to access additional settings and configuration options; Press to return to the previous screen when indicated.

Understanding the Home Screen

When you turn on your Fishfinder 400C, the Home screen appears. Press up or down on the **ROCKER**, and then press **SELECT** to choose an option.



NOTE: Options on this screen vary based on the type of transducer installed.



Home Screen
(Dual Beam)

Home Screen
(Dual Frequency)

Full Screen

Opens a full-screen graph of the transducer's sonar readings ([page 17](#)).

Flasher (Dual Beam transducer only)

Opens a round flasher to indicate the transducer's sonar readings as an alternative to the linear graph ([page 18](#)).

Split Freq (Dual Frequency transducer only)

Opens a split-screen that uses the full capability of the dual frequency transducer. A 50kHz frequency graph appears on the left; a 200kHz frequency graph appears on the right ([page 18](#)).

Split Zoom

Opens a split-screen with the normal graph on the right zoomed to your preferred level on the left ([page 17](#)).

Numbers

Opens a set of data fields to show information numerically ([page 19](#)).

Temp Log

Shows a customizable graph of the water temperature when using a compatible transducer or sensor ([page 19](#)).

Configure

Configure unit settings ([page 20](#)).

Understanding the Full Screen

The Full Screen is the main screen for both dual beam and dual frequency transducers.

On the Home screen, highlight **Full Screen**, and press **SELECT**.

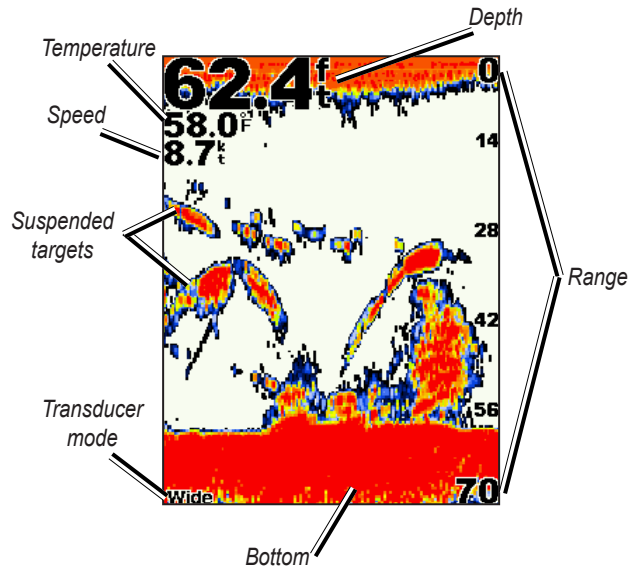

Understanding the Split Zoom Screen

Use the Split Zoom screen to view the full sonar data from the graph as well as a zoomed in portion on the same screen.

On the Home screen, highlight **Split Zoom Screen**, and press **SELECT**.

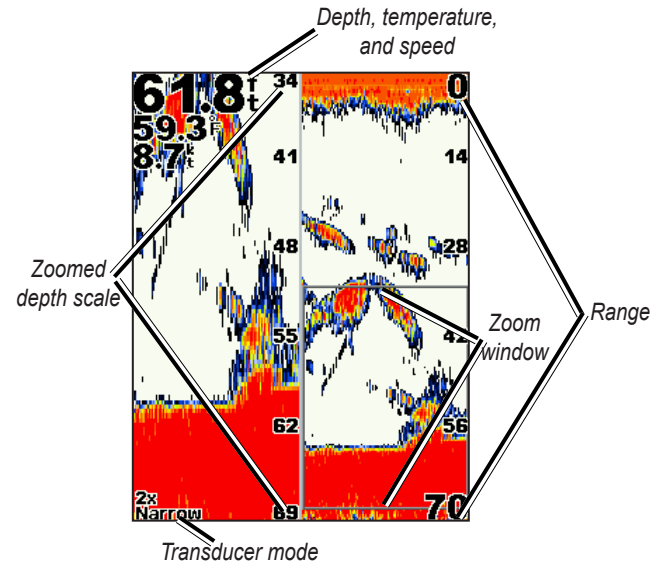

Understanding the Flasher Screen

The Flasher screen (dual beam transducer only) provides an almost instantaneous return of what is below your boat. The depth scale is organized as a ring that starts at the top, or 12:00, and progresses clockwise. Sonar information flashes on the ring when it is received at the depth indicated on the inside ring. Like the regular graph, The colors indicate different strengths of the sonar return.

On the Home screen, highlight **Flasher**, and press **SELECT**.

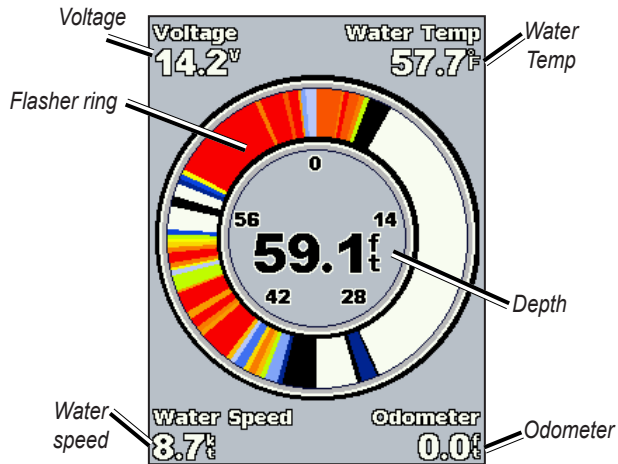

Understanding the Split Freq Screen

Use the Split Freq screen (dual frequency transducer only) to view both the 50kHz and 200kHz frequencies on the same screen.

On the Home screen, highlight **Split Freq**, and press **SELECT**.

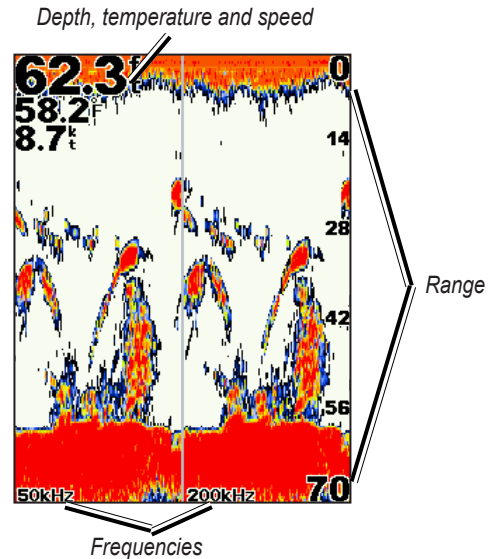

Understanding the Numbers Screen

The Numbers screen shows data fields populated by important numeric information instead of a graph. The data fields you see are determined by the capabilities of your transducer.

On the Home screen, highlight **Numbers**, and press **SELECT**.

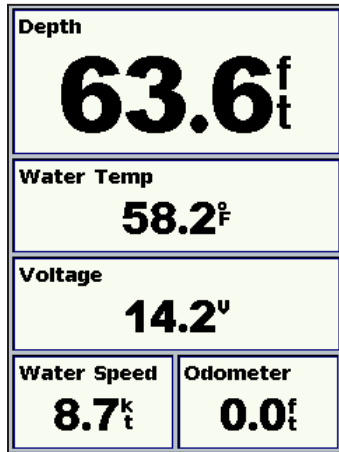

All transducers show depth. If you are using a temperature-capable transducer, the Water Temp field appears. If you are using a speed-capable transducer, the Water Speed and Odometer fields appear.

Understanding the Temp Log Screen

If you are using a temperature-capable transducer, the Temp Log screen keeps a graphic log of temperature readings over time. The current temperature and depth are shown in the top left corner.

On the Home screen, highlight **Temp Log**, and press **SELECT**.

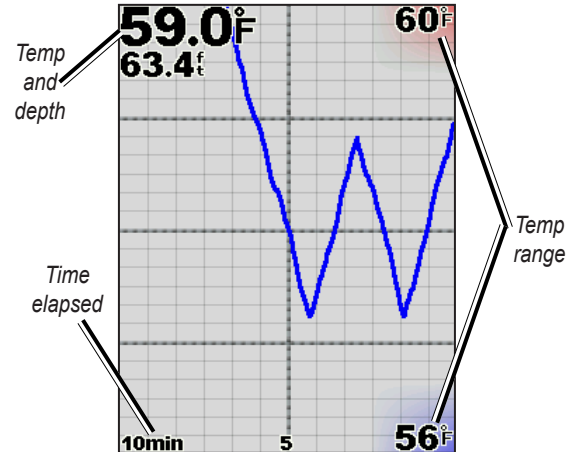

The temperature appears along the right side and the time elapsed appears along the bottom. The graph scrolls to the left as information is received.

Understanding the Configure Screen

The Configure screen contains the main configuration options for the Fishfinder 400C. From this screen, you can define and adjust settings universal to all Fishfinder 400C screens.

On the Home screen, highlight **Configure**, and press **SELECT**.



Alarms—set alarms to alert you of various events. See [page 21](#).

Display—customize display settings including backlight and Day/Night mode. See [page 21](#).

Sonar—customize sonar settings. See [page 22](#).

System—set various system options. See [page 23](#).

Transducer—set transducer options. See [page 23](#).

Units—customize the units of measure shown on Fishfinder 400C screens. See [page 24](#).

For more information on the Configure screen, see the “[Customizing the Fishfinder 400C](#)” section beginning on [page 21](#).

CUSTOMIZING THE FISHFINDER 400C

Setting Alarms

You can set the Fishfinder 400C to sound an audible alarm when certain conditions are met. By default, all alarms are turned off.

To set an alarm, on the Configure screen, highlight **Alarms**, and press **SELECT**.

Shallow Water/Deep Water—set an alarm to sound when the depth is less than or greater than the specified value.

Fish—set an alarm to sound when the unit detects a suspended target of the specified symbols.

Water Temp—set an alarm to sound when the transducer reports a temperature that is 2° F (1.1° C) above or below the specified temperature.

Battery—set an alarm to sound when the battery reaches a user-determined low voltage.

Drift—set an alarm to sound when the depth changes by the value specified.

Changing the Display Settings

You can switch between Day and Night modes and brighten or darken the backlight.

To change the display settings, on the Configure screen, highlight **Display**, and press **SELECT**.

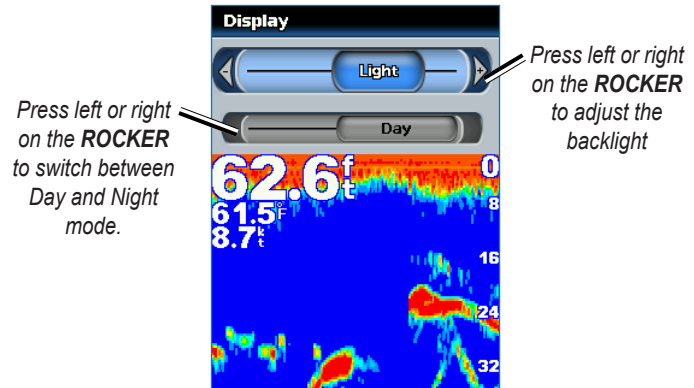

Changing the Sonar Settings

To change the sonar settings, on the Configure screen, highlight **Sonar**, and press **SELECT**.

Color Scheme—choose white or blue. This affects the background on all sonar screens, but does not change the Numbers or Temp Log screens.

Fish Symbols—set how the Fishfinder 400C interprets suspended targets.



The Fishfinder 400C does not interpret the sonar return data. (default)



Suspended targets appear as symbols. Background sonar information appears, making the distinction between fish and structure easier.



Suspended targets appear as symbols with background information shown. The target depth of each symbol is also indicated.



Suspended targets appear as symbols. No background information appears.



Suspended targets appear as symbols with no background information shown. The target depth of each symbol is indicated.

Scroll Speed—adjust the rate at which the sonar scrolls from right to left (**Ultrasroll**, **Fast**, **Medium**, or **Slow**). If you have a speed-capable transducer, select **Auto** to have the scroll speed automatically adjust to your vessel's water speed.

Surface Noise—show or hide the sonar returns near the surface of the water. Hide surface noise to help reduce clutter.

Whiteline—highlights the strongest signal from the bottom to help identify its hardness or softness.

- **Off**—(default) Whiteline is disabled.
- **High**—the most sensitive setting. Almost all stronger returns are highlighted in white.
- **Medium**—many stronger returns are highlighted in white.
- **Low**—the least sensitive setting. Only the strongest returns are highlighted in white.

Numbers—show or hide battery voltage, water temperature, or water speed (if your transducer is capable).



NOTE: To show water temperature or water speed, change the setting to **Auto**. If the connected transducer is capable, the data is shown.

Changing the System Settings

To change the system settings, on the Configure screen, highlight **System**, and press **SELECT**.

Beeper—set when the unit makes audible sounds. The three settings are **Off**, **Alarms Only** (default), and **On** (keys and alarms).

Simulator—turn on the Simulator to have the Fishfinder 400C act as though a transducer is connected.

NMEA Output— connect the Fishfinder 400C to NMEA compatible electronic equipment (such as a Garmin GPS device) and send information. To do so, you must change this setting to **On**. For more information on connecting to a NMEA device, see [page 12](#).

Language—select the on-screen language.

System Information—view the current operating software version and your unit's unique internal unit ID.

Factory Settings—reset the Fishfinder 400C to the factory settings. You are prompted to confirm your choice to restore all factory settings. Choose **Yes**. Otherwise, choose **No** to retain your current configuration.

Configuring Transducer Settings

To change the transducer settings, on the Configure screen, highlight **Transducer**, and press **SELECT**.

Type—select the transducer type (**Dual Frequency** or **Dual Beam**).

Keel Offset—offset the surface reading for the depth of a keel so you can measure depth from the bottom of your keel instead of from the transducer's location. Enter a positive number to offset for a keel. You can enter a negative number to compensate for a large vessel that may draw several feet of water.

Transducer at Surface

Enter (+) positive number to show depth from the bottom of keel.

Transducer at Bottom of Keel

Enter (-) negative number to show depth from the surface.

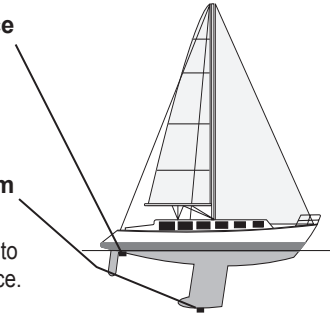

To adjust the Keel Offset:

1. Highlight **Keel Offset**, and press **SELECT**.
2. Use the **ROCKER** to set the value of the keel offset.
3. Press **SELECT** to accept the number.



NOTE: Press **MENU** to cancel your changes and return to the Transducer menu.

Calibrate Water Speed—to use a speed sensing transducer, use this menu to calibrate the speed sensor. If you are not using a speed sensing transducer, this menu does not appear.

To calibrate the speed sensor:

1. Highlight **Calibrate Water Speed**, and press **SELECT**.
2. Bring the boat to cruising speed. Note your top speed, and then stop the boat.
3. Highlight **OK**, and press **SELECT**.



NOTE: If the boat is not moving fast enough or the speed sensor is not registering a speed, a “**Speed Too Low**” message appears. Highlight **OK**, press **SELECT**, and safely increase boat speed. If you get the message again, stop the boat and make sure the speed sensor wheel is not stuck. If the wheel turns freely, check the cable connections. If you continue to get the message, contact Garmin Product Support.

Customizing Units of Measure

To change the units of measure, on the Configure screen, highlight **Units**, and press **SELECT**.

Depth—select Feet (ft), Meters (m), or Fathoms (fa).

Water Temp—select Fahrenheit (°F) or Celsius (°C) (with a compatible transducer).

Water Speed—select Miles/Hour (mh), Kilometers/Hour (kh), or Knots (kt) (with a compatible transducer).

Distance—select Statute (mi), Metric (km), or Nautical (nm) (with a compatible transducer).

ADVANCED SETTINGS

Press **MENU** on any screen to access advanced options.

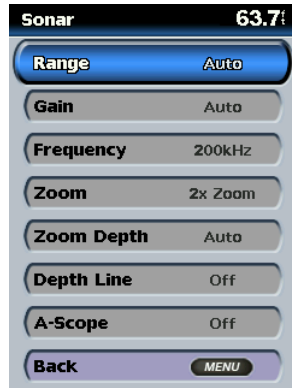

Dual Frequency

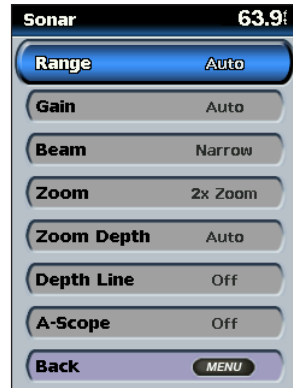

Dual Beam

Range—By default, the range is set to **Auto**. The range of the depth scale on the right side of the screen adjusts automatically as the depth readings increase or decrease. Highlight **Manual Range** and press **SELECT** to manually adjust the scope of the depth scale.

Gain—controls the sensitivity of the Fishfinder 400C's sonar receiver. By default, the Gain is set to **Auto**, which automatically sets the sonar sensitivity.

Highlight **Manual Gain**, and press **SELECT** to manually adjust the Gain. To see more detail, increase the Gain. If there is too much detail, or the screen is cluttered, decrease the Gain.

Beam—when using a Dual Beam transducer, select a wide or narrow beam.

Frequency—when using a Dual Frequency transducer, select how the frequencies appear on screen. By default, the frequency is set to 200kHz. You can specify that the unit uses only the 200kHz frequency, the 50kHz frequency, or Dual Frequency.



NOTE: If you choose **Dual**, the Split Freq screen appears.

Zoom—zoom in to a section of the Full Screen. The zoom is off, or set to **No Zoom** by default. Four options are available:

- **2x Zoom**—twice the magnification.
- **4x Zoom**—four times the magnification.
- **Bottom Lock**—locks the zoom window to the bottom. The default zoom span is 10 ft, and can be adjusted.
- **Split Zoom**—opens the Split Zoom screen.

Zoom Depth (While Zoomed)—available only when you are using a 2x or a 4x Zoom. By default, the Zoom Depth is set to **Auto** and automatically adjusts with the depth. You can adjust this setting to zoom in at a specific depth.

Span (While Zoomed with Bottom Lock)—While using Bottom Lock, this option replaces the Range option. Adjust this setting just as you would the Range setting to expand or contract the zoomed distance from the bottom.

Depth Line—turn on the depth line to quickly reference a specific depth on the Full Screen, Split Zoom screen, or Split Freq screen. While viewing a screen showing the Depth Line, press up or down on the **ROCKER** to move the line.

A-Scope (Dual Frequency Transducer)—vertical flasher that appears along the right side of the screen. The A-Scope indicates structure and bottom returns much like the Flasher screen ([page 18](#)). The horizontal width of a signal in the A-Scope indicates the strength of the signal.

Resetting the Odometer

If you are using a speed sensing transducer, an odometer is available on the Numbers screen and the Flasher screen that tracks the distance you travel.

To reset the odometer:

1. Press **MENU**.
2. Highlight **Reset Odometer**, and press **SELECT**.
3. Highlight **Yes**, and press **SELECT**.

Setting the Temp Log Duration and Scale

On Temp Log screen, press **MENU** to view advanced options.

Duration—set the scope of time along the bottom of the graph.

Scale—set the temperature span along the right side of the graph.

APPENDIX

Specifications

Physical Specifications

Size: 5" H x 5.7" W x 3" D (12.7 cm x 14.5 cm x 7.62 cm)

Weight: 1.20 lbs (.544 kg)

Display: 4.0" diagonal (10.19 cm), 3.21" H x 2.41" W (8.16 cm x 6.12 cm), QVGA display with adjustable brightness, 320 x 240 pixels, capable of 4,096 colors.

Case: Fully gasketed, high-impact plastic alloy, waterproof to IEC 529 IPX7 standards.

Temp. Range: 5°F to 131°F (-15°C to 55° C)

Power Source: 10-35 VDC

Usage: 21 Watts max at 12 VDC

Fuse: AGC/3AG - 3.0 Amp

Sonar

Power: Dual Frequency, 500 Watts (RMS), 4,000 Watts (peak to peak);
Dual Beam, 400 Watts (RMS), 3,200 Watts (peak to peak)

Frequency: 50/200 kHz (dual frequency), 80/200 kHz (dual beam)

Depth: 1,500 ft (dual frequency), 900 ft (dual beam)

(Depth capacity is dependent on water salinity, bottom type, and other water conditions.)

Optional Accessories

You can purchase the following optional accessories on the Garmin Web site (www.garmin.com):

Flush Mount Kit—mounts your fishfinder flush on the bulkhead or cabin wall.

CANet™ Connection Kit—allows you to connect your Fishfinder 400C to CANet-capable Garmin chartplotters, so you can read sonar displays on chartplotters located elsewhere in the boat.

Alarms and Messages

The Fishfinder 400C uses an on-screen message system to alert you to unit operating characteristics. When a message appears, press **SELECT** to acknowledge the message and return to the screen you were viewing.

Battery Alarm—battery voltage has fallen below the value entered in the Battery Alarm setup.

Battery Voltage Is Too High—too much input voltage; the unit shuts off in 10 seconds. Decrease the input voltage to 35 Volts or less.

Boat Is Not Moving Fast Enough to Calibrate—the boat is not moving fast enough for the speed wheel to provide a valid speed.

Can't Read Voltages That High, Limited to Top of Range—the voltage value in the Battery Alarm setup is higher than the unit can read.

Can't Read Voltages That Low, Limited to Bottom of Range—the voltage value in the Battery Alarm setup is lower than the voltage where the unit automatically turns off.

Deep Water Alarm—the Deep Water Alarm depth has been reached.

Drift Alarm—the depth has changed by the amount of the Drift Alarm value.

Fish Alarm—an icon appears and a beep sounds (if enabled) when a fish is detected. This alarm does not show a message banner.

Shallow Water Alarm—the Shallow Water Alarm depth has been reached.

Simulating Operation—the unit is in Simulator Mode.

Sonar Failed, Unit Needs Repair—there is an internal problem with the fishfinder. Contact your dealer or Garmin Product Support to have the unit serviced.

Transducer Disconnected, Sonar Turned Off—there is not a transducer attached, bad cable/transducer, or the transducer cable was disconnected. If the transducer cable is removed while the unit is on, reconnect and cycle power.

Water Speed Sensor Is Not Working—the speed sensor is not detected. Check the connections.

Entering (Leaving) target water temperature—the target water temperature is 2° F (1.1° C) above or below the temperature specified by the Water Temperature Alarm. These messages appear when you enter or leave that zone.

Limited Warranty

This Garmin product is warranted to be free from defects in materials or workmanship for one year from the date of purchase. Within this period, Garmin will, at its sole option, repair or replace any components that fail in normal use. Such repairs or replacement will be made at no charge to the customer for parts or labor, provided that the customer shall be responsible for any transportation cost. This warranty does not cover failures due to abuse, misuse, accident, or unauthorized alteration or repairs.

THE WARRANTIES AND REMEDIES CONTAINED HEREIN ARE EXCLUSIVE AND IN LIEU OF ALL OTHER WARRANTIES EXPRESS, IMPLIED, OR STATUTORY, INCLUDING ANY LIABILITY ARISING UNDER ANY WARRANTY OF MERCHANTABILITY OR FITNESS FOR A PARTICULAR PURPOSE, STATUTORY OR OTHERWISE. THIS WARRANTY GIVES YOU SPECIFIC LEGAL RIGHTS, WHICH MAY VARY FROM STATE TO STATE.

IN NO EVENT SHALL GARMIN BE LIABLE FOR ANY INCIDENTAL, SPECIAL, INDIRECT, OR CONSEQUENTIAL DAMAGES, WHETHER RESULTING FROM THE USE, MISUSE, OR INABILITY TO USE THIS PRODUCT OR FROM DEFECTS IN THE PRODUCT. Some states do not allow the exclusion of incidental or consequential damages, so the above limitations may not apply to you. Garmin retains the exclusive right to repair or replace the unit or software or offer a full refund of the purchase price at its sole discretion. SUCH REMEDY SHALL BE YOUR SOLE AND EXCLUSIVE REMEDY FOR ANY BREACH OF WARRANTY.

To obtain warranty service, contact your local Garmin authorized dealer or call Garmin Product Support for shipping instructions and an RMA tracking number. Securely pack the unit and a copy of the original sales receipt, which is required as the proof of purchase for warranty repairs. Write the tracking

number clearly on the outside of the package. Send the unit, freight charges prepaid, to any Garmin warranty service station.

Online Auction Purchases: Products sold through online auctions are not eligible for rebates or other special offers from Garmin. Online auction confirmations are not accepted for warranty verification. To obtain warranty service, an original or copy of the sales receipt from the original retailer is required. Garmin will not replace missing components from any package purchased through an online auction.

International Purchases: A separate warranty is provided by international distributors for units purchased outside the United States. This warranty is provided by the local in-country distributor and this distributor provides local service for your unit. Distributor warranties are only valid in the area of intended distribution. Units purchased in the United States or Canada must be returned to the Garmin service center in the United Kingdom, the United States, Canada, or Taiwan for service.

Garmin International, Inc.
1200 East 151st Street,
Olathe, Kansas 66062, USA
Tel. (913) 397-8200 or
(800) 800-1020
Fax (913) 397-8282

Garmin (Europe) Ltd.
Liberty House
Hounslow Business Park,
Southampton, Hampshire, SO40 9RB UK
Tel. +44 (0) 870.8501241 (outside the UK)
0808.2380000 (within the UK)
Fax +44 (0) 870.8501251

Garmin Corporation
No. 68, Jangshu 2nd Road,
Shijr, Taipei County, Taiwan
Tel. 886/2.2642.9199
Fax 886/2.2642.9099

Declaration of Conformity (DoC)

Hereby, Garmin, declares that this Fishfinder 400C is in compliance with the essential requirements and other relevant provisions of Directive 1999/5/EC.

To view the full Declaration of Conformity, see the Garmin Web site for your Garmin product: www.garmin.com/products/fishfinder400c/. Click **Manuals**, and then select the **Declaration of Conformity** link.

Software License Agreement

BY USING THE FISHFINDER 400C, YOU AGREE TO BE BOUND BY THE TERMS AND CONDITIONS OF THE FOLLOWING SOFTWARE LICENSE AGREEMENT. PLEASE READ THIS AGREEMENT CAREFULLY.

Garmin grants you a limited license to use the software embedded in this device (the “Software”) in binary executable form in the normal operation of the product. Title, ownership rights, and intellectual property rights in and to the Software remain in Garmin.

You acknowledge that the Software is the property of Garmin and is protected under the United States of America copyright laws and international copyright treaties. You further acknowledge that the structure, organization, and code of the Software are valuable trade secrets of Garmin and that the Software in source code form remains a valuable trade secret of Garmin. You agree not to decompile, disassemble, modify, reverse assemble, reverse engineer, or reduce to human readable form the Software or any part thereof or create any derivative works based on the Software. You agree not to export or re-export the Software to any country in violation of the export control laws of the United States of America.

INDEX

- A**
- A-scope 26
 - accessories 27
 - advanced settings 25
 - alarms 21, 28
 - battery 21
 - deep water 21
 - drift 21
 - fish 21
 - shallow water 21
 - water temp 21
 - arches 22
- B**
- backlight
 - adjusting 15
 - basic operation 15
 - beam 25
 - bottom lock 25
 - bracket assembly 2
- C**
- calibrate the speed sensor 24
 - CANet 12, 27
 - caring for the fishfinder iii
 - cleaning
 - the case iii
 - the screen iii
- D**
- clutter. *See* surface noise
 - configure screen 20
 - contact garmin iii
 - customizing
 - sonar settings 22
 - system settings 23
 - transducer settings 23
 - units of measure 24
 - Declaration of Conformity 30
 - depth 24
 - line 26
 - range 25
 - span 26
 - zoom 26
 - display settings
 - changing 21
 - distance 24
 - duration 26
- F**
- factory settings
 - restoring 23
 - fish symbols 22
 - flasher 18, 26
 - flush mount 2, 27
 - frequency 25
 - full screen 17
 - fuse 10, 27
- G**
- gain 25
 - GPS, wiring to a 12
- H**
- HOME key 15
 - Home screen 16
- I**
- important information iv
 - input voltage 10
 - installing 1
 - selecting a location 1
 - testing 13
 - the fishfinder on the mounting
 - bracket 3
 - the mount 2
 - the transducer 4
 - on a transom 6
 - on a trolling motor 5
 - shoot-thru-hull 8
 - the wiring harness 10
 - to a Garmin CANet 12
 - interfacing with NMEA 12
- K**
- keel offset 23
 - adjusting 24
 - keypad
 - using 15
- L**
- language
 - changing 23
 - LCD screen 1
 - limited warranty 29
 - location for shoot-thru-hull installation 9
 - location for the fishfinder 1
- M**
- MENU key 15
 - messages 28
 - mounting
 - bracket 3
 - bracket assembly 2
 - transducer on a transom 7
 - transducer on a trolling motor 5
- N**
- NMEA 12
 - NMEA device
 - connecting to 12
 - noise. *See* surface noise
 - numbers 22
 - numbers screen 19
- O**
- odometer
 - resetting 26
 - optional accessories 27

P

physical specifications 27
POWER/BACKLIGHT key 15
power/data and transducer cables 1, 3
product registration iii

Q

quick links i

R

range 25
RANGE keys 15
registration. *See* product registration
reset odometer 26
ROCKER key 15

S

scale 26
scroll speed 22
selecting a location for shoot-thru-hull
installation 8
SELECT key 15
setting alarms. *See* alarms
settings
advanced 25–26
display 21
sonar 22
system 23
transducer 23

shoot-thru-hull installation 8
simulator mode 23
using 15
software license agreement 30
sonar
specifications 27
sonar settings
changing 22
specifications 27
speed sensor 24
split frequency screen 18
split zoom screen 17
surface mounting the fishfinder 2
surface noise 22
suspended targets 22
swivel base 3
swivel mount bracket 3
system information
viewing 23

T

temperature range for the fishfinder 1
temp log screen 19
test the installation 13
tips and shortcuts i
transducer 8
assembling 4
cables 1
dual beam 5, 18, 23

dual frequency 18, 23, 25
installing 4–7
settings 23

transom 7
transom, mounting on a 6
transom mount installation 14
trolling motor, mounting on a 5

U

Ultrasroll 12

V

voltage 10

W

warnings iv
warranty. *See* limited warranty
waterproof. *See* water immersion
water immersion iii
water speed 24
calibrate 24
water temperature 24, 28
whiteline 22
wiring harness
installing 10–12

Z

zoom 25
2x 25
4x 25
depth 26
split 17, 25

**For the latest free software updates (excluding map data) throughout the life of your
Garmin products, visit the Garmin Web site at www.garmin.com.**



© 2006, 2007 Garmin Ltd. or its subsidiaries

Garmin International, Inc.
1200 East 151st Street, Olathe, Kansas 66062, USA

Garmin (Europe) Ltd.
Liberty House, Hounsdown Business Park, Southampton, Hampshire, SO40 9RB UK

Garmin Corporation
No. 68, Jangshu 2nd Road, Shijr, Taipei County, Taiwan

www.garmin.com

Part Number 190-00757-00 Rev. C